



特性

- ◆光电隔离
- ◆可提供透明防护盖
- ◆4000V 介质耐压
- ◆过零或随机导通开关
- ◆面板安装
- ◆SCR 反并联输出
- ◆内置 RC 吸收回路
- ◆LED 指示工作状态
- ◆环保产品（符合 ROHS 要求）

输入（控制）参数（TA=25℃）

输入电压范围（直流）	3-32VDC
确保接通电压（直流）	3.0VDC
确保关断电压（直流）	1.0VDC
输入电流(典型值)	12mA
输入电流(最大值)	15mA
反极性电压（直流）	-32VDC

其它参数（TA=25℃）

介质耐压	4000VAC(输入与输出间) 2500VAC（输入、输出与底座间）
绝缘电阻	1000MΩ（500VDC）
工作温度范围	-30℃~80℃
储存温度范围	-30℃~100℃
重量	约 110g

输出（负载）参数（TA=25℃）

输出电压范围	40~480VAC
最大瞬态电压	1100Vpk
最大输出漏电流	5mA
最大输出压降	1.5Vrms
最大负载电流	100A
最大浪涌电流 (10ms)	额定电流的 10 倍
最小功率因数	0.5
最大接通时间	1/2 周期+1ms
最大关断时间	1/2 周期+1ms
断态电压指数 上升率 dv/dt	500V/μs

产品介绍:

SSR-DAH 系列为小型大功率固态继电器，输入控制电压为 3-32VDC，输出采用单向可控硅反并联，耐 dv/dt 能力高，输出负载电压范围 40-660VAC，最大负载电流 100A。极大的满足了客户各种不同场合的需要。该产品输入与输出之间采用光电隔离，其介质耐压达到 4000VAC。采用环氧树脂灌封，外型尺寸：57.4mm×45.7mm×23mm

SSR-DAH 系列固态继电器被广泛应用于电炉温控、橡胶塑料机械、印刷机械、包装机械、喷泉控制、数控机床、舞台灯光等工业自动化领域。

订货标记示例

SSR - □ D A □



性能曲线图

漏电流与负载电压特性图 (@25°C)

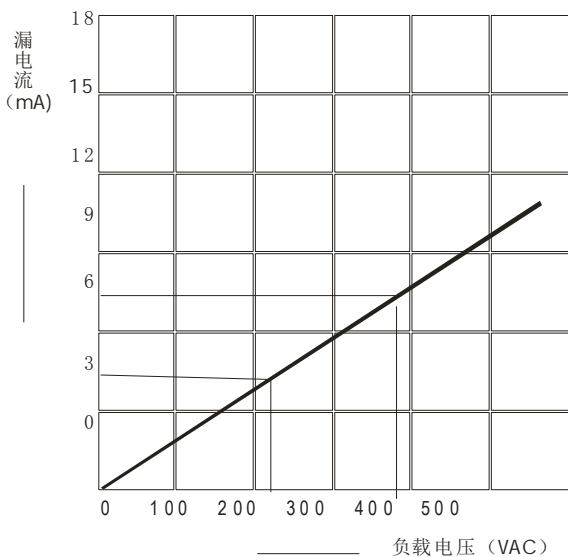

最大负载电流与环境温度特性图 (100A)

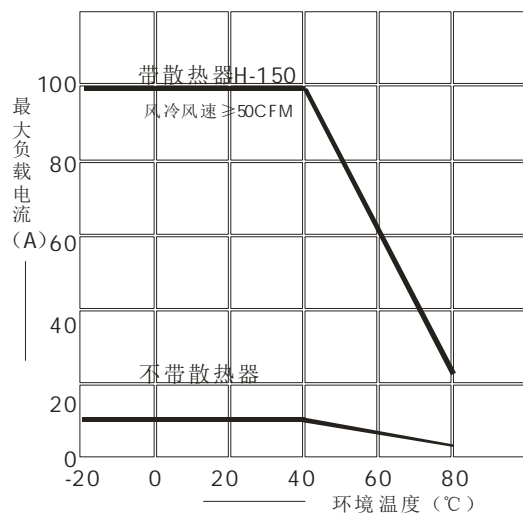

外型安装尺寸图:

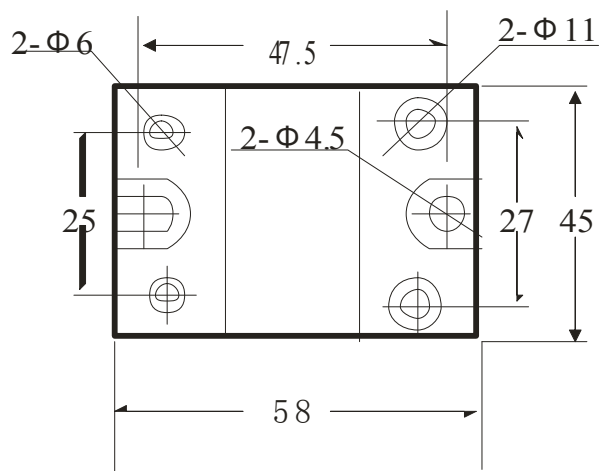

ENVIRONMENTAL INFORMATION 环保信息

The environmental information disclosed including the EIP Pollution logo are in compliance with People's Republic of China Electronic Industry Standard SJ/T11364 – 2006, Marking for Control of Pollution Caused by Electronic Information Products. If you want to know more information, please click on the official website: www.hzgjckj.com

Matters needing attention 注意事项

Note:

1. When the environment temperature for more than 40 °C or solid state relay installed together, users should consider derating use according to the temperature curve.
2. If the load current exceeds 10 A, should add the appropriate heat sinks to protect the solid state relay.
3. The inductive load selection solid-state relay current should be 5 to 7 times of load current.
4. When two or more quantity of solid state relay installed side by side, should keep enough distance (more than 10 mm). More than
5. When Shared a solid state relay control power supply, control input can be used in series or parallel. But must ensure that each solid state relay have enough input drive current.
6. In the load circuit, please quick fuse or circuit breaker series, in order to prevent the load short circuit.
7. Part of the high current surge load selection solid-state relay should be 10 times more than the actual load current.

If you want to know more information, please click on the official website: www.hzgjckj.com